



The heart of smart control



**Bi-Fuel Power
Control Solutions**



**Generate
electricity
using gas that is
usually flared
That's smart
control**

ComAp ► specialises in creating electronic control and management solutions for use in the power generation industries and drive power markets. Our portfolio of products, software and accessories is designed to support emergency power, standby power generation and engine driven applications all over the world.

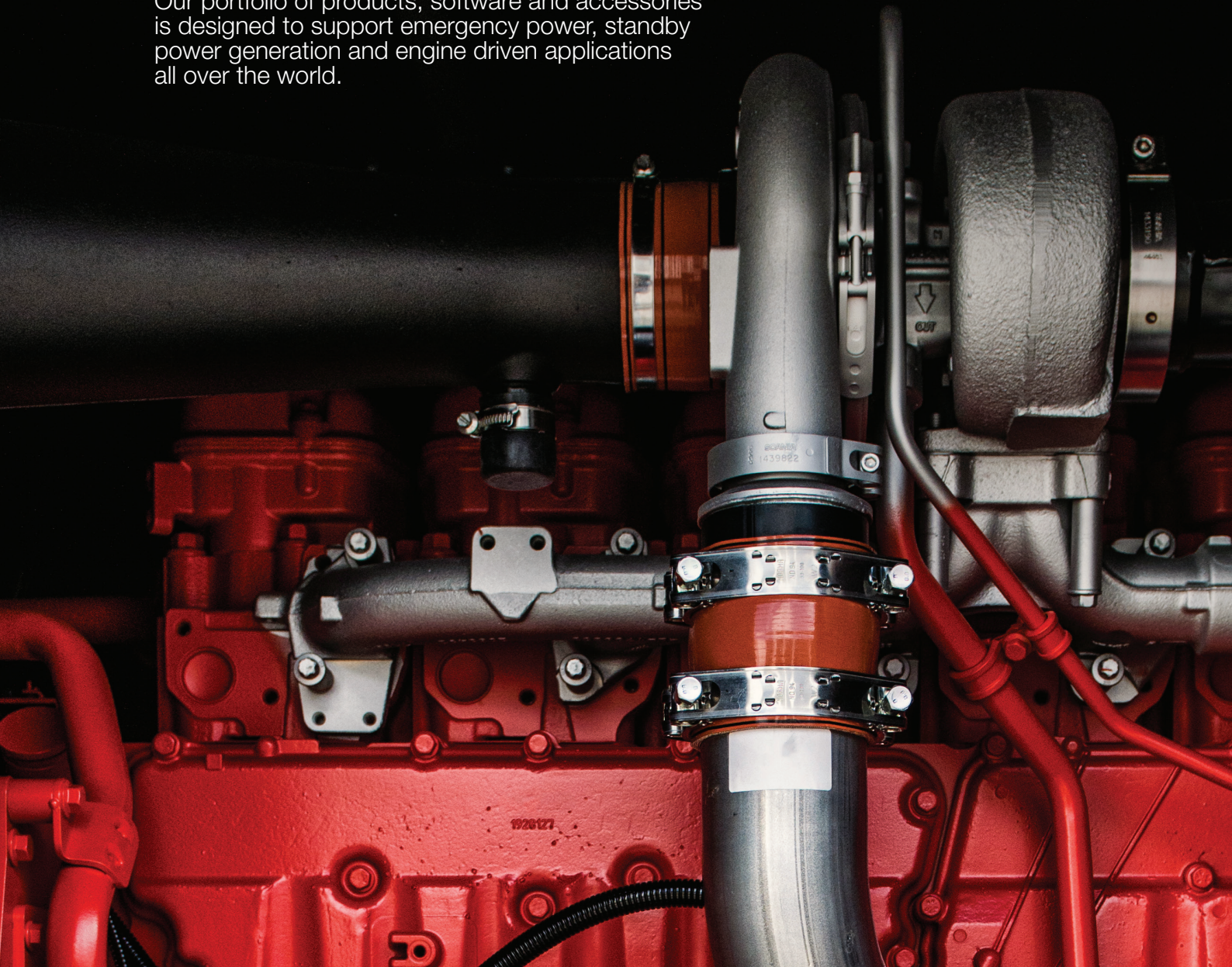

Offices

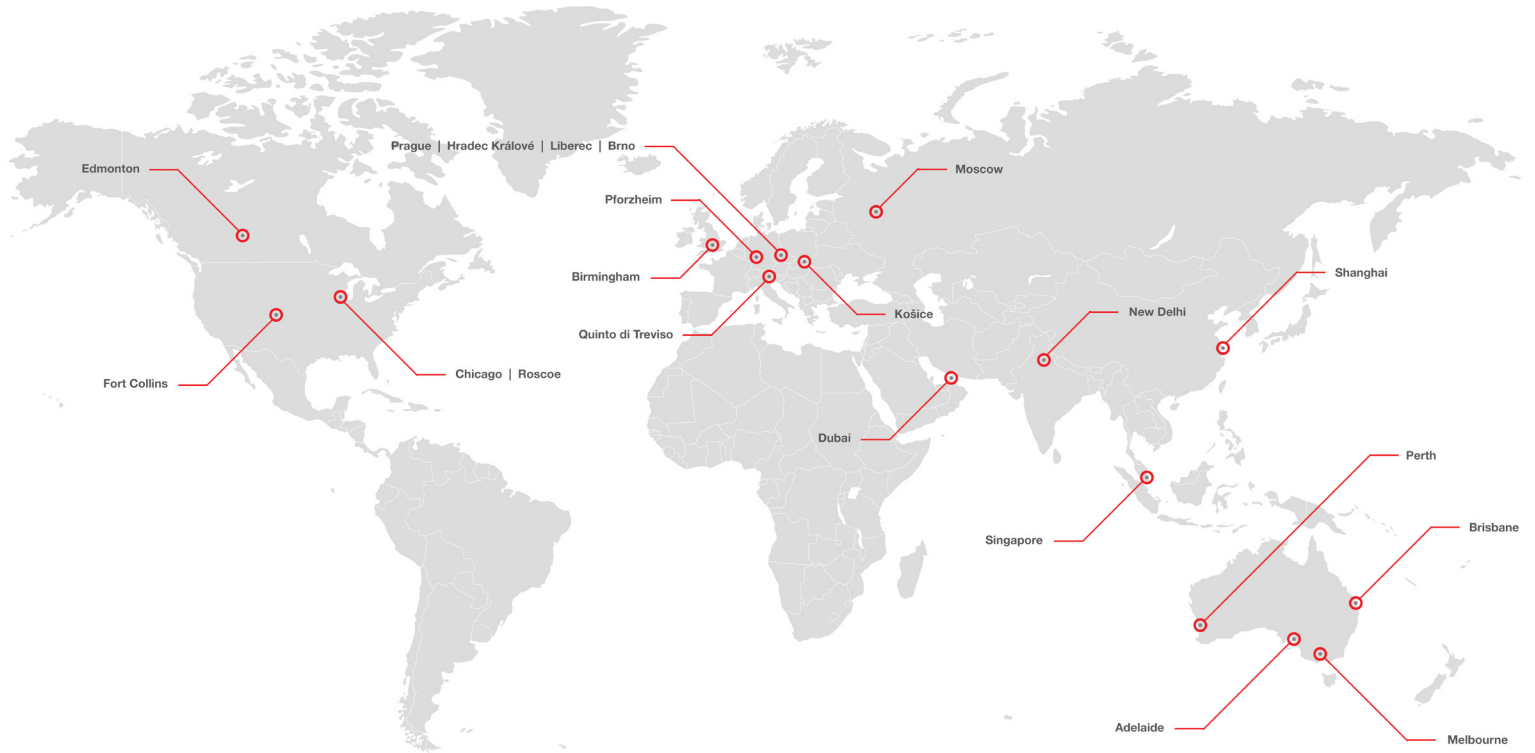

400+ Employees



21 Offices



60+ Distributors

InteliBifuel Solutions

Use Gas Instead of Diesel - Save Money and the Environment

We have developed an easy to fit bi-fuel management package which converts your diesel engine to run primarily on gas.

ComAp has solutions for both stationery and mobile engines, with significant savings to be made with either solution.

ComAp's bi-fuel system is ideally suited to generator packagers and original equipment manufacturers (OEMs) looking to deliver more economically beneficial power packages.

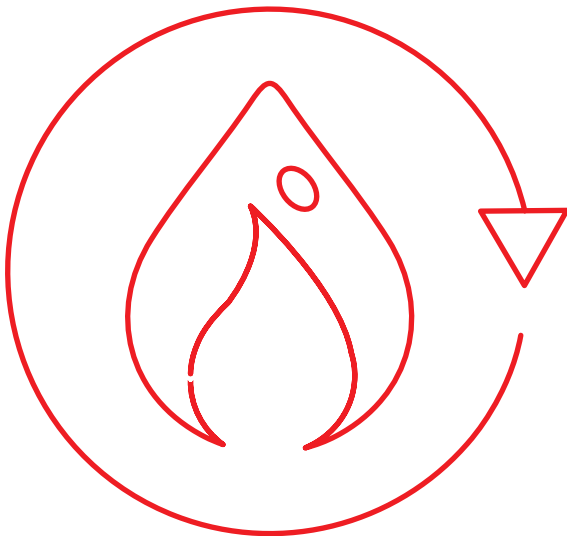

Gas tank

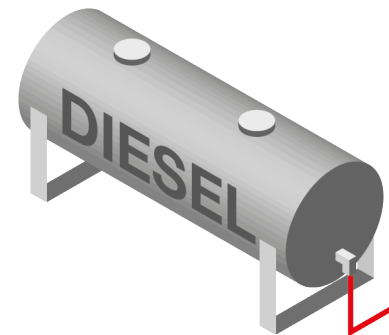

Diesel tank

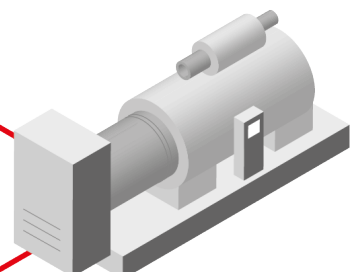
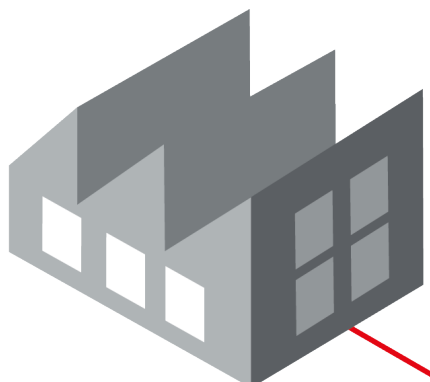
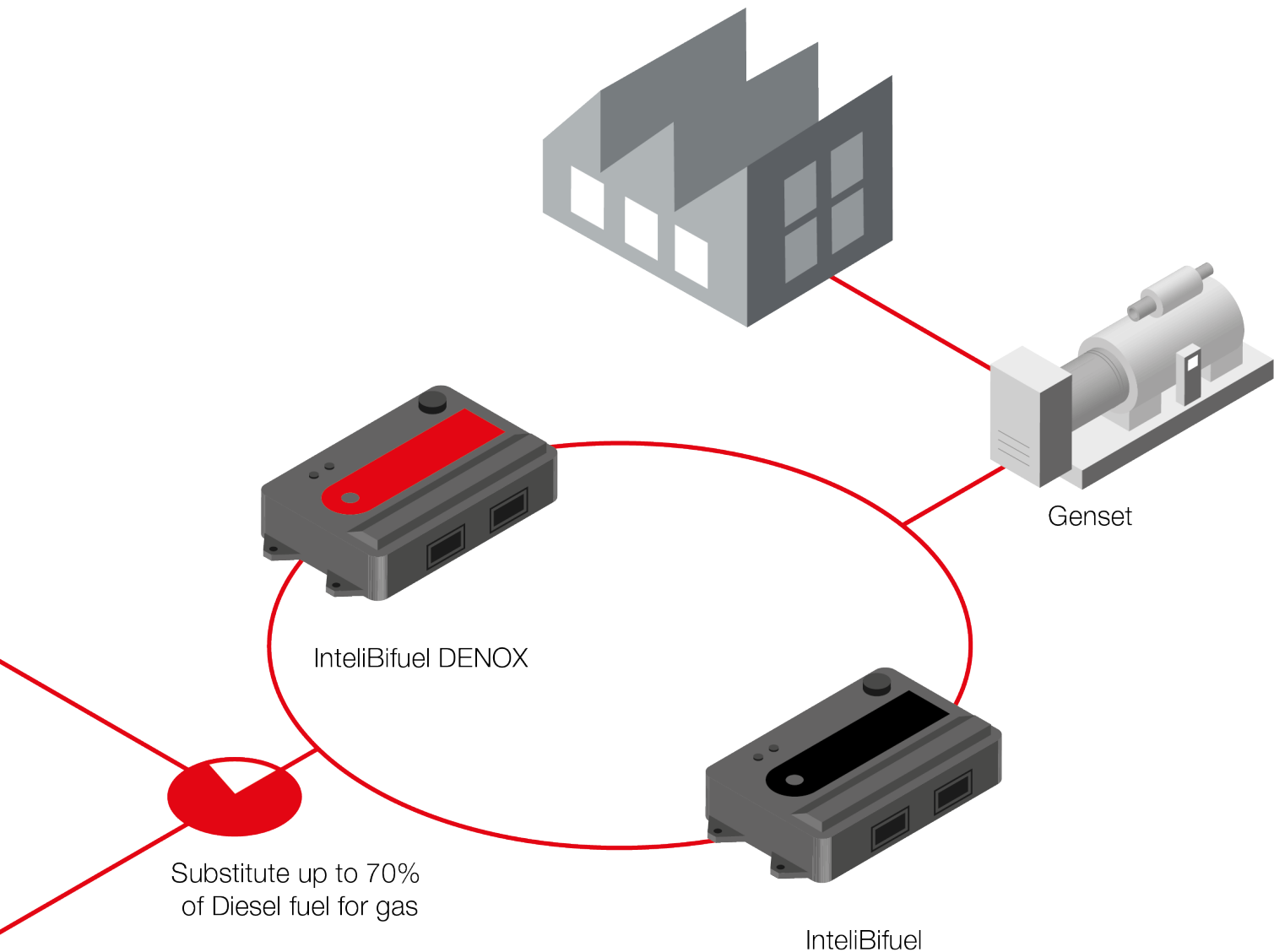

Genset

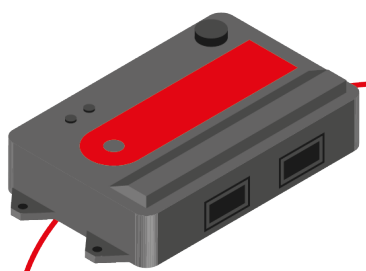

IntelIBifuel DENOX

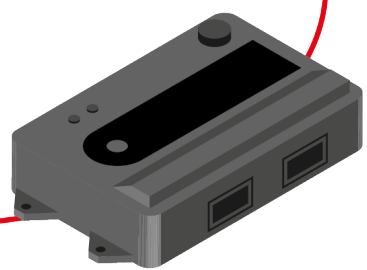

IntelIBifuel



Substitute up to 70%
of Diesel fuel for gas

InteliBifuel Key Benefits

Save Money and the Environment

Lower Fuel Costs

- > Up to 70% diesel consumption replaced by gas
- > Dramatically reduced operational costs
- > It enables the ongoing use of existing assets
- > Reduced maintenance costs – no ignition system
- > Seamless and automatic changeover to 100% diesel operation

Simply Adaptive

- > Fully automatic compensation for changes in:
 - gas quality (typically Oil&Gas applications)
 - gas pressure
 - temperatures
- > InteliBifuel ensures best performance in every situation





Environmentally Friendly

- > Significant reduction in engine emissions:
 - NO_x , PM
 - SO_x , CO_2
- > With the use of a catalytic converter, can also reduce CO

Fuel Flexibility

- > Extended run times without refueling
- > Smooth transition between diesel and Bi-fuel mode at any time
- > IntelliBifuel maintains the output of the diesel engine
- > IntelliBifuel maintains the transient performance of the diesel engine

Solutions

Solutions for both stationery and mobile engines

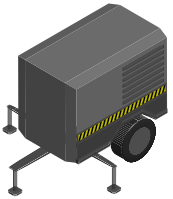

Small Single Speed Engines (up to 500 kW)

InteliBifuel LITE packages are cost effective, compact solutions designed for single speed Bi-Fuel applications at nominal output power of up to 500 kW. They are available in two variants: InteliBifuel LITE 100 and InteliBifuel LITE 500, for engines up to 100 kW and up to 500 kW respectively. These solutions are perfect for the Rental market or any other Power Generation applications using any type of gas.

- > High or low pressure single point gas injection technology, gas injected before or after the turbocharger
- > Algorithm with automatic compensation for gas quality changes
- > Easy installation and commissioning
- > Harsh environmental design
- > IP-69 enclosure fits to any application
- > Compatible with InteliVision displays

Single Speed Engines

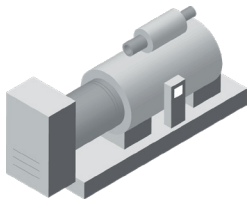

InteliBifuel package is a fully programmable solution designed for any single speed Bi-fuel application, with its features perfectly suitable for Oil & Gas, Mining and Rental applications.

- > Algorithm with automatic
- > Enable factory setting of Bi-fuel system
- > Simplified installation and commissioning
- > Extended PLC logic and history
- > GPRS/GSM remote monitoring
- > IP-69 enclosure fits to any application
- > Optional high pressure single point gas injection after turbocharger
- > Compatible with InteliVision displays

Variable Speed Engines

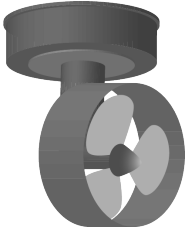

InteliBifuel MOBILE package is a fully programmable solution designed for any mobile variable speed applications as Mine haul trucks, Frack trucks, Locomotives or Marine propulsion engines.

- > Fully configurable 3D maps
- > IP-69 Harsh environmental design allows full integration in applications with limited space
- > Remote monitoring
- > GPRS/GSM remote monitoring
- > GPS Location
- > Extended PLC logic
- > Extensive history records
- > Optional high or low pressure single point gas injection technology; gas injected before or after the turbocharger
- > Compatible with InteliVision displays

Integrated solution for Power generation

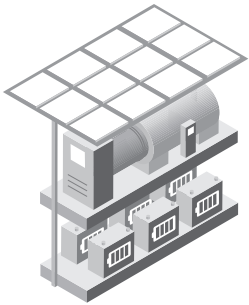

Fully integrated solution combining features of the InteliBifuel LITE or InteliBifuel controller with Antiknocking protection system InteliBifuel DENOX and the power generation controller InteliGenNT BaseBox with InteliVision 5. It offers our customers a single interface for both applications. This integrated solution is suitable for applications with limited space (such as Rental) or any other Power generation application, from stand-by power, right up to multiple engine parallel operations.

- > Integrated system allowing up to 64 generators paralleled on a single bus
- > Isochronous load sharing, DROOP or Emergency DROOP and Power management
- > Simplified installation and commissioning
- > Single and Multiple genset operation
- > Automatic priority swap and Redundant communication
- > Automatic system addressing for ease of installation and adding removing gensets from site
- > InteliVision family displays bring the controls to one HMI (InteliVision 5 – standard; InteliVision 8 – optional)
- > InteliGen and InteliBifuel share system and critical information for integrated power generation and Bi-fuel control in one package
- > Display of critical power, engine, alternator and Bi-fuel data, with customizable screens
- > Remote monitoring from WebSupervisor and remote access via AirGate
- > Ready to incorporate renewable energy sources

ComAp Bi-fuel high pressure single point injection system

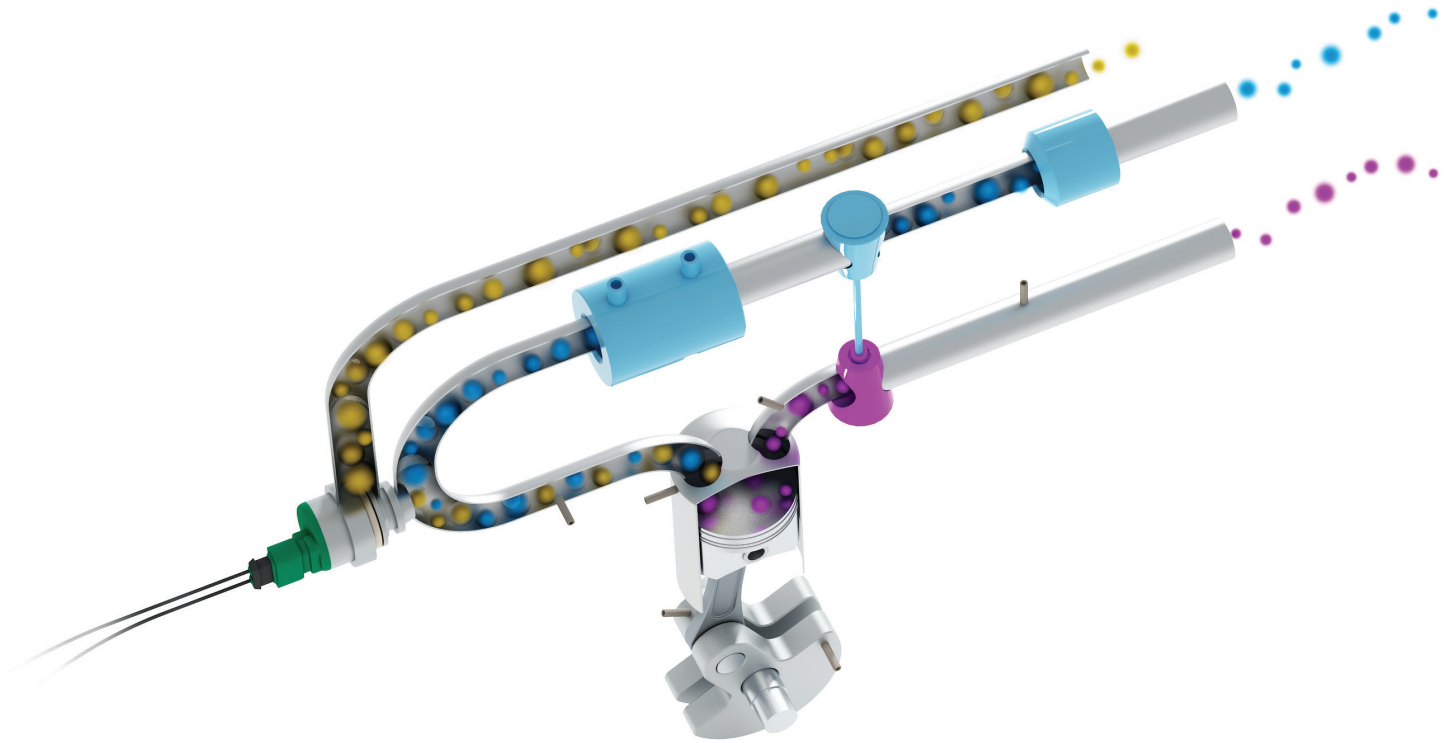

Together with ComAp's new generation of IntelliBifuel controllers we have developed technology capable of delivering gas into the engine via high pressure injectors.

Single point injectors are placed after the turbocharger enabling the ComAp controller precise gas portion control with higher efficiency and increased safety. Simplified gas delivery into the engine air manifold offers ideal cost effective solution.

This technology is available to applications using new IntelliBifuel products.

ComAp Bi-fuel low pressure fumigation system

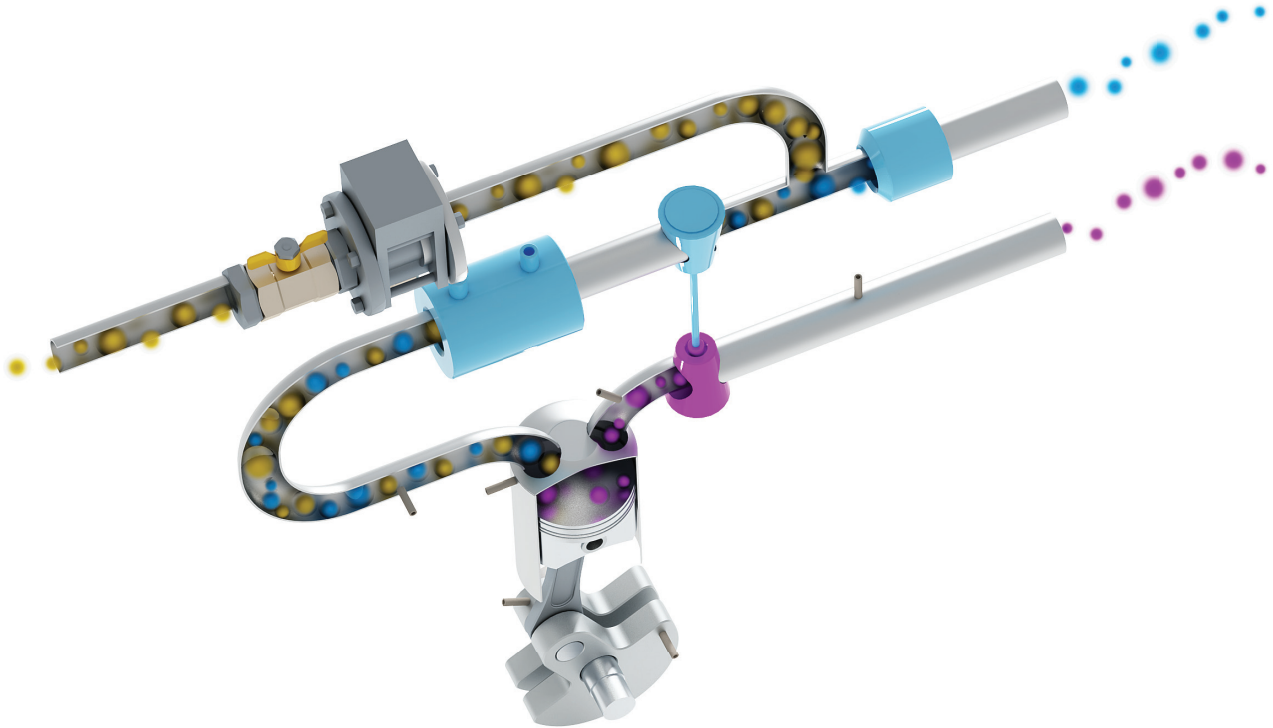

This system has been in use for many years and is widely used for high-speed engines. Gas is introduced into the engine before the turbocharger and controlled by a gas throttle valve.

This system is suitable for applications where the high-pressure single point injection system is not suitable.

Power generation using flare gas

In this application the Bi-fuel system uses flare-gas to substitute the diesel portion of the fuel. This application is particularly efficient as it uses gas that would normally be burned as a waste product during oil production.

ComAp InteliBifuel solution with new algorithm is able to react on various gas quality to set up the optimal diesel/gas ratio to provide the best possible performance and safety during Bi-fuel operation.

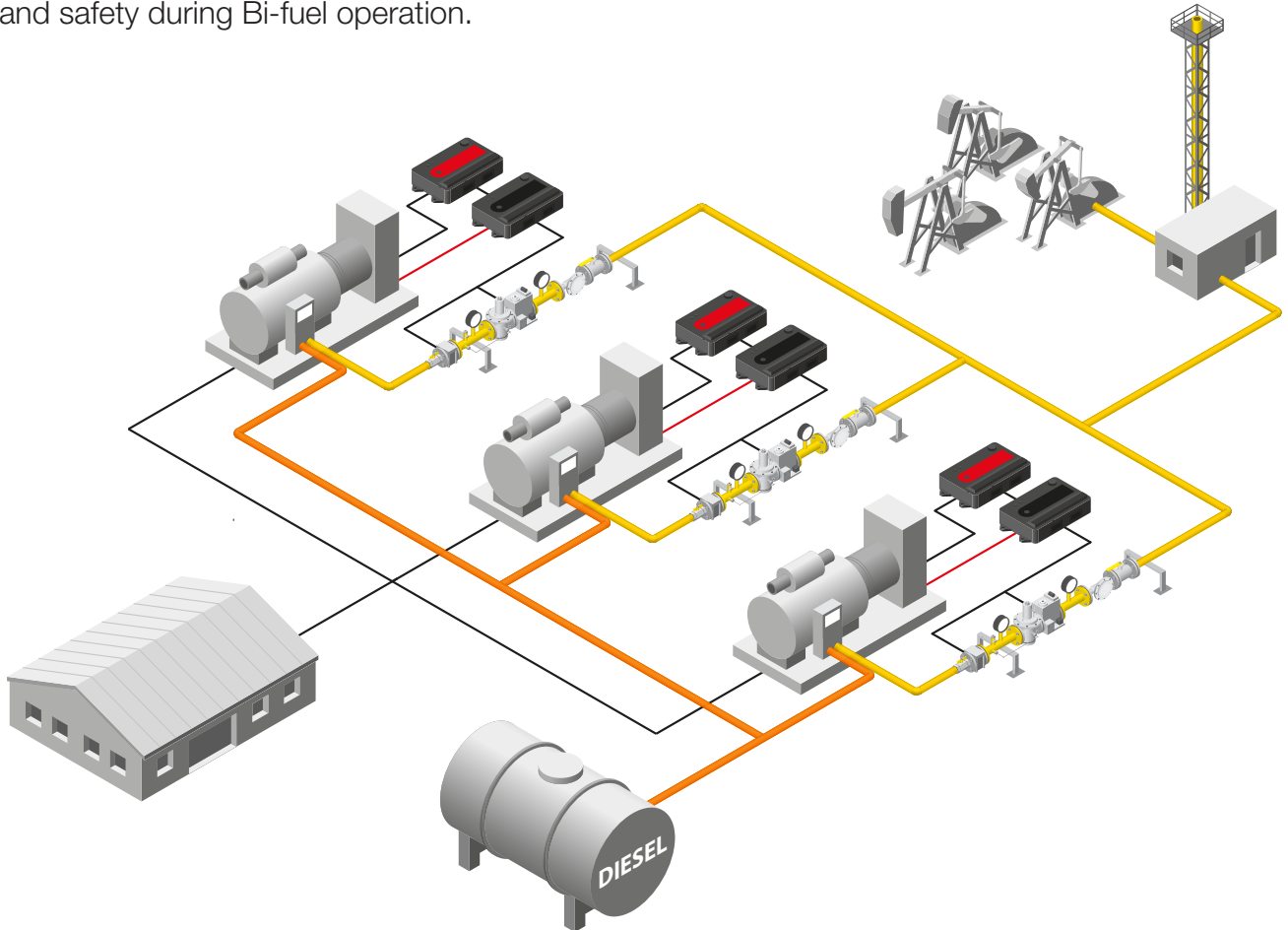

Remote mine power with stored gas

In this application natural gas is provided from on-site storage tanks, alongside the standard diesel tanks, which are refilled as normal. This is particularly useful for 'semi-permanent' or rental power generation applications such as mines, holiday resorts or long-term construction sites.

The ComAp Bi-fuel solution brings operational costs reduce as well as it is more environmentally friendly. Up to 70 % diesel fuel is replaced by LNG. There is significant reduce NO_x , PM , SO_x and CO_2 emissions compare to 100% diesel operation.

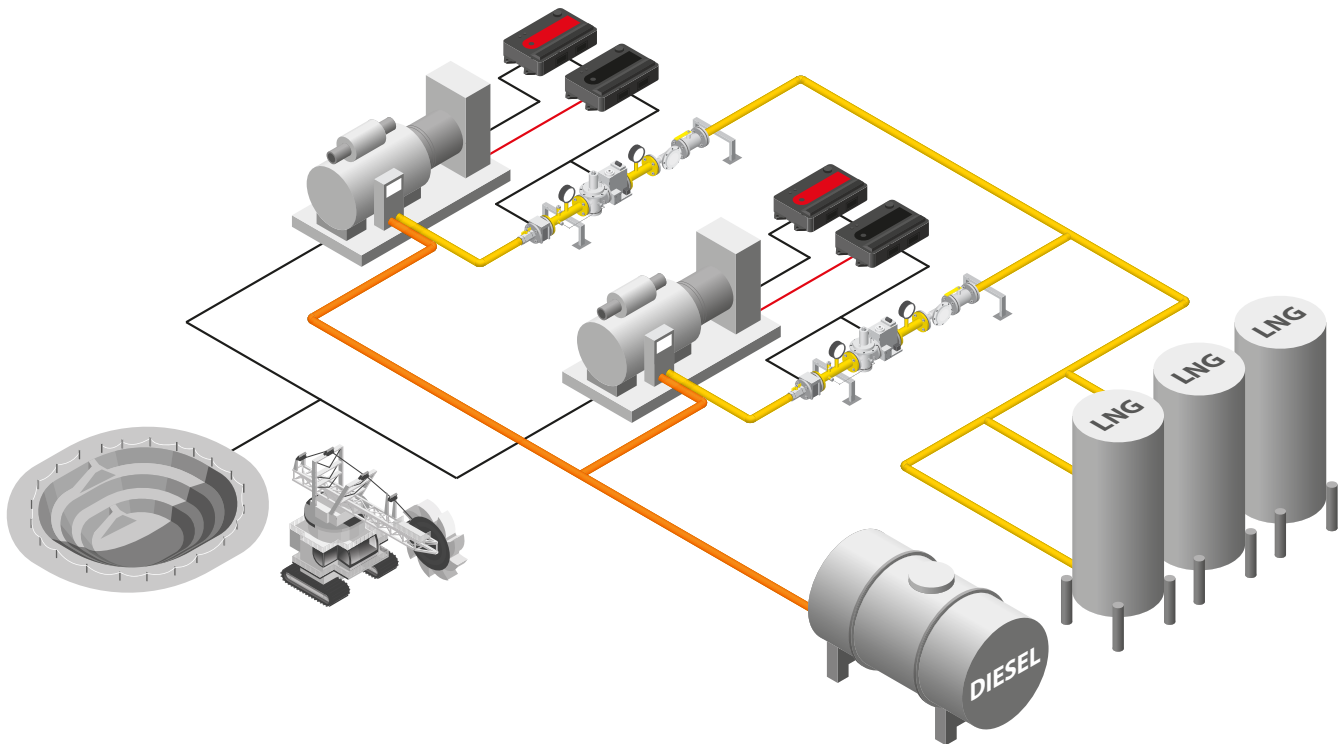

Virtual pipeline gas distribution

In many places of the world gas infrastructure is not well established yet and gas distribution is available through CNG or LNG virtual pipeline by trucks. IntelliBifuel is great option how to use gas from virtual pipelines and enable to any diesel generator to run back on 100 % diesel.

The ComAp unique integrated solution controls the diesel/gas ratio, as well as controlling the paralleling of the generators, which can all be monitored from a single control point.

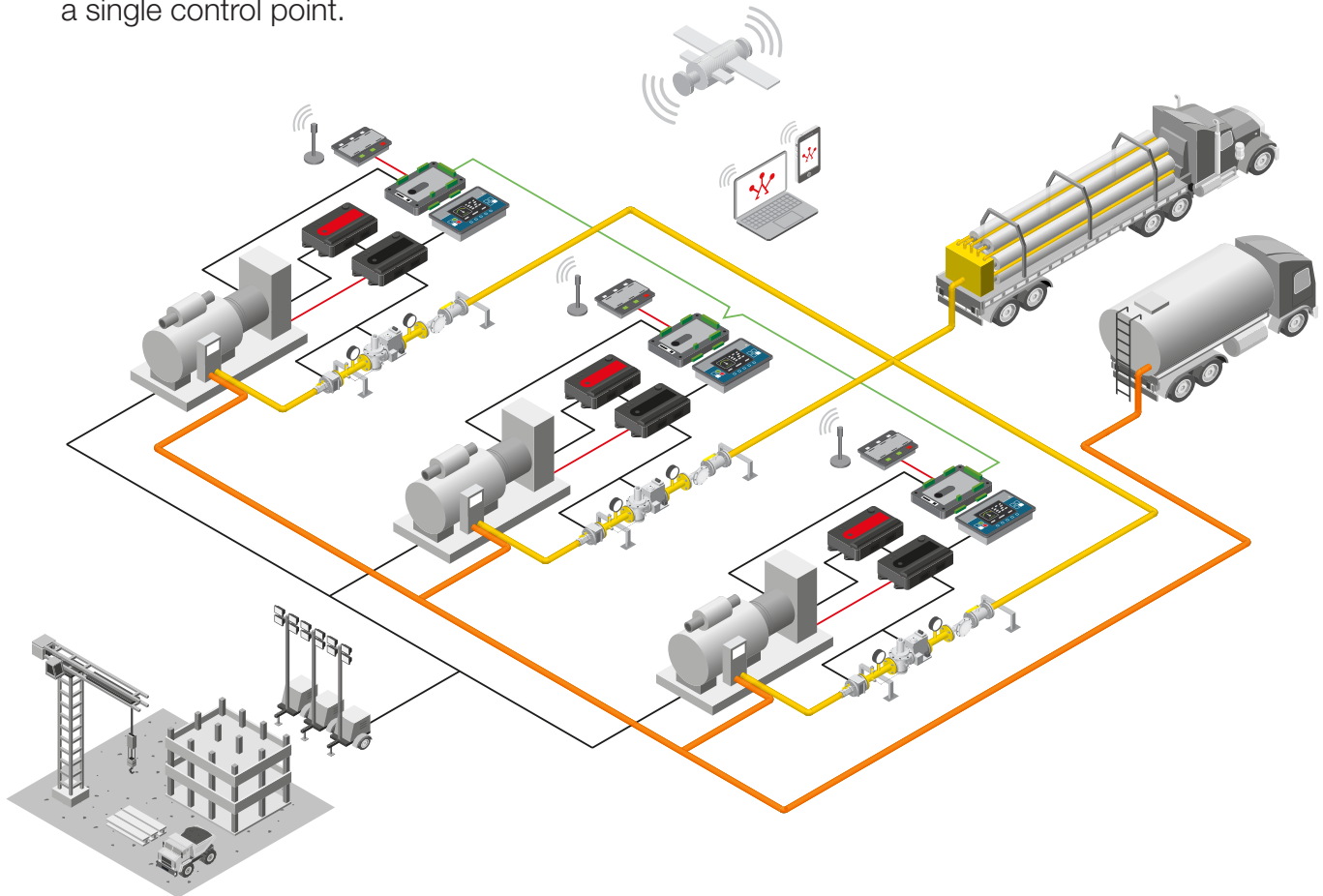

InteliBifuel

Bi-fuel/dual fuel control system
for single speed engines



- > InteliBifuel package is a fully programmable solution designed for any single speed Bi-fuel application, with its features perfectly suitable for Oil & Gas, Mining and Rental applications
- > New algorithm with automatic compensation for gas quality changes
- > Enable factory setting of Bi-fuel system
- > Simplified installation and commissioning
- > Extended PLC logic and history
- > Optional GPRS/GMS and GPS monitoring
- > IP-69 enclosure fits to any application
- > Optional high pressure single point gas injection after turbocharger
- > Compatible with InteliVision 5, and InteliVision 8 displays

InteliBifuel DENOX

Bi-fuel anti-knocking device



- > Unique anti knocking engine protection controller specifically designed for Bi-fuel applications, ensure proper detonation is always maintained during Bi-fuel operation
- > Suitable for engines up to 20 cylinders
- > Suitable for variable speed engines
- > Individual cylinder knocking detection
- > Individual cylinder misfiring detection
- > Integrated 2x Inteli AIN8TC up to 16 thermocouples
- > Harsh environmental design IP69K
- > Full communication and direct CAN interface to InteliBifuel LITE, InteliBifuel and InteliBifuel MOBILE
- > Operating temperature: -40°C to +80°C > CE, UL, CSA

InteliBifuel LITE

Bi-fuel/dual fuel control system
for low-powered engines



- > InteliBifuel LITE package is a cost effective, compact solution designed for single speed Bi-fuel applications at nominal output power up to 100 or 500kW.
- > Perfectly suitable for the Rental market or any other Power generation applications using any type of gas
- > High or low pressure single point gas injection technology, gas injected before or after the turbocharger
- > NEW algorithm with automatic compensation for gas quality changes
- > Easy installation and commissioning
- > Harsh environmental design
- > IP-69 enclosure fits to any application
- > Compatible with InteliVision 5, and InteliVision 8 displays

InteliBifuel MOBILE

Bi-fuel/dual fuel control system
for mobile variable speed engines



- > InteliBifuel MOBILE package is a fully programmable solution designed for any mobile variable speed applications as Mine haul trucks, Frack trucks, Locomotives or Marine propulsion engines
- > Fully configurable 3D maps
- > IP-69 Harsh environmental design allows full integration in applications with limited space
- > Remote monitoring
- > GPRS/GSM remote monitoring
- > GPS Location
- > Extended PLC logic
- > Extensive history records
- > Optional high or low pressure single point gas injection technology; gas injected before or after the turbocharger
- > Compatible with InteliVision displays

InteliDrive Mobile Logger

Data Logger for Diesel Engine Driven
Mobile and Industrial Applications



- > Data logger – outstanding, monitoring and history tracking for diesel engines as well as peripheral equipment
- > Plug and play support of engines with ECU – access to all available values
- > Built-in Event & Performance Log
- > Remote monitoring support
- > Fleet management program with GSM/GPS localization and Geofencing
- > History log out
- > Engine measurement by sensors and actuators or via J1939
- > 8 Binary inputs
- > 11 Configurable analog inputs
- > 1× Frequency input for RPM measurement
- > 2× Impulse inputs
- > LED status indication
- > Communication Interface RS485, 2× CAN, J1939
- > Possibility to connect with external displays
- > Running-hours meter, number of starts counter, battery voltage measurement
- > Integral fuel consumption measuring

InteliDrive Mobile

Electronic Controller for Off-road
Vehicles and Machinery



- > Diesel/gas engine control, monitoring and protection for off-road applications such as construction, quarrying and engineering equipment
 - > Control of hydraulic systems and engine driven compressors and pumps
 - > Designed for harsh environments – the unit construction features a fully environmentally sealed enclosure and connector
 - > Plug & Play EFI (ECU) engine support (CAN/J1939)
 - > Master Slave Concept Support
 - > Remote monitoring support
 - > Fleet management via GPRS/GPS, GeoFencing
 - > Integrated PLC functions: Analog switches, Comparators with delay or hysteresis, Counters, Delay functions, Filters, Linear interpolation, Logical and Mathematical functions, PID loops, Timers
 - > Built-in event & Performance Log
 - > History log out – monitoring of wide range of parameters
 - > 4 Binary inputs with detection of broken wire
 - > 12 Binary bi-directional inputs for contacts switching
 - > 8 Binary configurable switches (High-side/Low-side 3A, PWM 3A, DC motor driver)
- > 8 Binary Hi-side switches with max. current 3A and detection of broken wire

Gas Train

Low pressure gas train for HSC

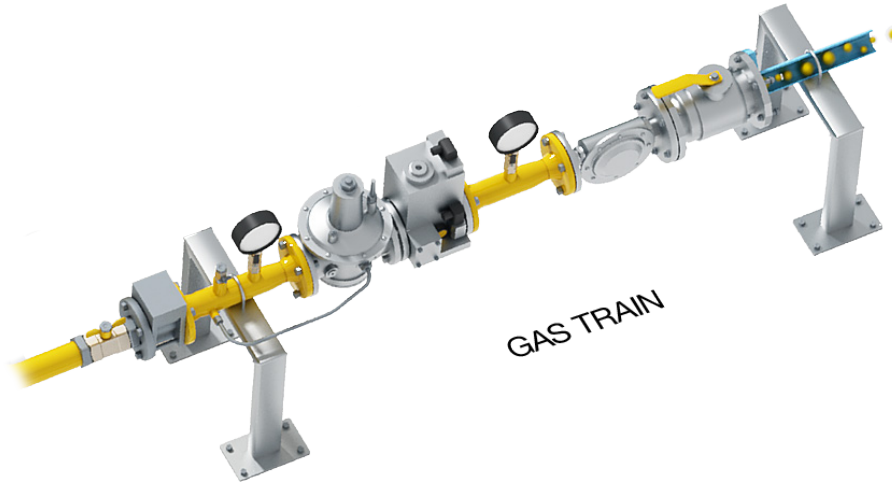

- > Assembly of components necessary to reduce and control gas flow into the engine
- > Suitable for High Speed engine Conversions
- > Ended with electronic throttle valve
- > Low pressure output 10 – 30mbar
- > Inlet pressure range 150 – 350 mbar
- > According gen-set power there are several types (dimensions):
- > Code name Note
- IBF-GT25 DN25, Outlet 1× 1BSP, up to 250kWe
- IBF-GT40 DN40, Outlet 2× 1BSP, 250 – 650 kWe
- IBF-GT50 DN50, Outlet 2× 5/4BSP, 600 – 1000 kWe
- IBF-GT50A DN50, Outlet 4× 1BSP, 600 – 1000 kWe
- IBF-GT65 DN65, Outlet 4× 5/4BSP, 1000 – 1650 kWe
- IBF-GT80 DN80, Outlet 4× 5/4BSP, 1650 – 2200 kWe

InteliVision 5

5,7" Colour Display Unit



- > Colour display unit for localized visualisation
- > InteliVision 5 is compatible with the following product line of controllers: InteliGenNT, InteliSysNT and InteliMainsNT
- > 5,7" Colour TFT Display with resolution of 320 × 240 pixels
- > Local and Remote display for single controller monitoring
- > Plug & Play operation (auto configuration based on controller application)
- > Direct connection to the controller (converters are not needed)
- > Simple, fast and intuitive controlEasy drag and drop screen configuration in graphical editor
- > Five active buttons – fast access to important data
- > Configurable active buttons
- > Support of Tiers 4 icons
- > Mounting screw available at the rear face of InteliVision 5 to mount a compatible controller
- > Same language support as the controller including graphic languages
- > Communication connection via RS-485 (galvanically separated)
- > Same cut out as InteliGenNT
- > Operating temperature: -30 to +70°C

InteliVision 12Touch

12,1" Colour Display Unit Touchscreen



- > Industrial operator panel equipped with 12,1" colour TFT multi-touch screen with resolution of 1280 × 800 pixels
- > Touch based Graphical User Interface, support for multi-touch gestures
- > Plug & Play operation (auto configuration based on controller application)
- > Complete access to all control and monitoring functions
- > Fast and intuitive navigation
- > Extended trends monitoring screen
- > Compatible with ScreenEditor software
- > USB flash disk file storage (export/import trends, history, archive of controller and InteliVision 12Touch firmware and others to a USB stick)
- > User's pictures import
- > Adaptive and colour AlarmList
- > Large History screen
- > Adjustable setpoints help
- > Communication connection via RS-485, CAN or Ethernet
- > Multilanguage support
- > Integrated easy to use mounting system
- > Designed to be mounted in either monitoring or engine room
- > Industrial and robust design
- > Rugged housing manufactured from a single piece of aluminium alloy
- > Chemically strengthened front glass (8 times stronger than normal glass)
- > Sun-readable display (1000 cd/m2)
- > Automatic brightness control
- > Operating temperature: -30 to + 70°C
- > Face is sealed to IP65
- > EMC, climatic and mechanical tests
- > CE certification
- > Supported controllers :
 - InteliSys GAS
 - InteliGenNT BaseBox
 - InteliGenNTC BaseBox
 - InteliSysNTC BaseBox
 - InteliMainsNTC BaseBox
 - InteliSysNTC Hybrid
 - InteliDrive DCU Marine from HW version 2.0
 - InteliDrive Mobile from SW version 2.6.0

WebSupervisor

A Cloud-based application that enables remote monitoring, management and analyses of a gen-set fleet and 3rd party devices from anywhere.

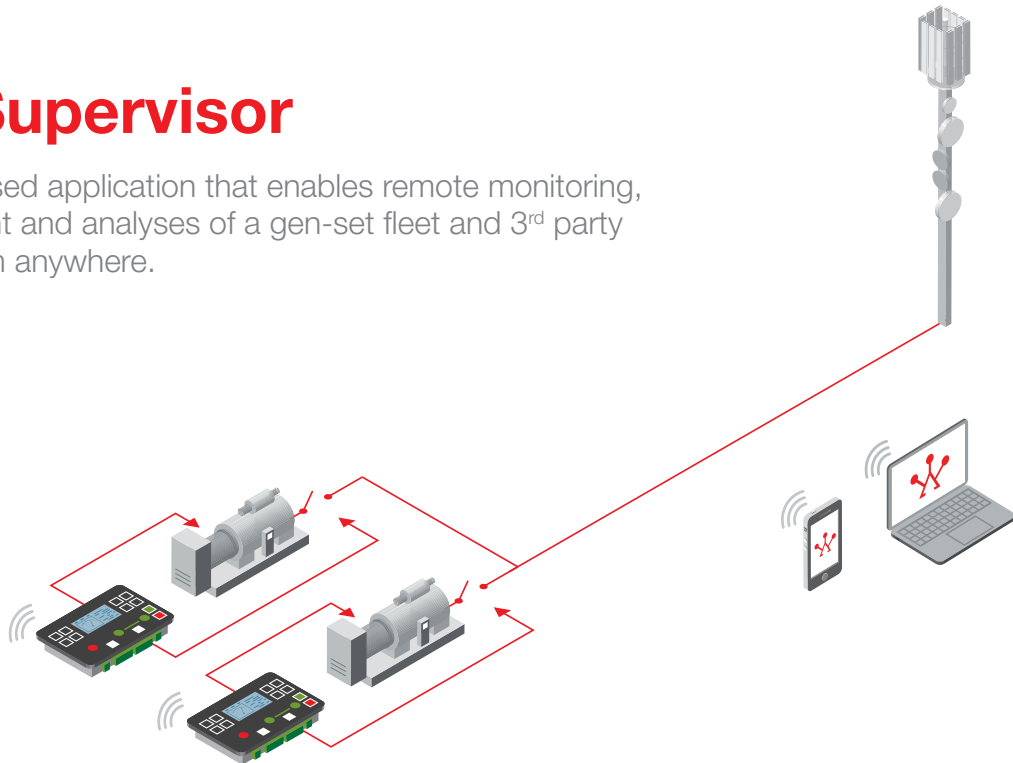

Main Features

- > List and map views of devices and alerts on one screen
- > Device tracking and geofencing*
- > Dashboard with fleet and group of devices statistics
- > Automatic reports for each device, or a group of devices, with customization options.
- > Alarm Analyser which can help reduce maintenance costs
- > Advanced trend representation (bar graphs, heat maps and more)
- > 3rd party device monitoring
- > API: able to download data and integrate in CRM, ERP, PowerBI or other third party software
- > Screen Editor: modify the data that is displayed according to your needs
- > Web camera support
- > User activity logger: logs all user activity for a device or fleet
- > Download controller's history files (event-based history)
- > Customizable look with your logo and URL
- > User management with several levels of permission

*Tracking and geofencing requires purchasing an additional GPS card.





WebSupervisor

From your PC,
tablet or mobile phone
you can instantly reach
the most important
and relevant data.

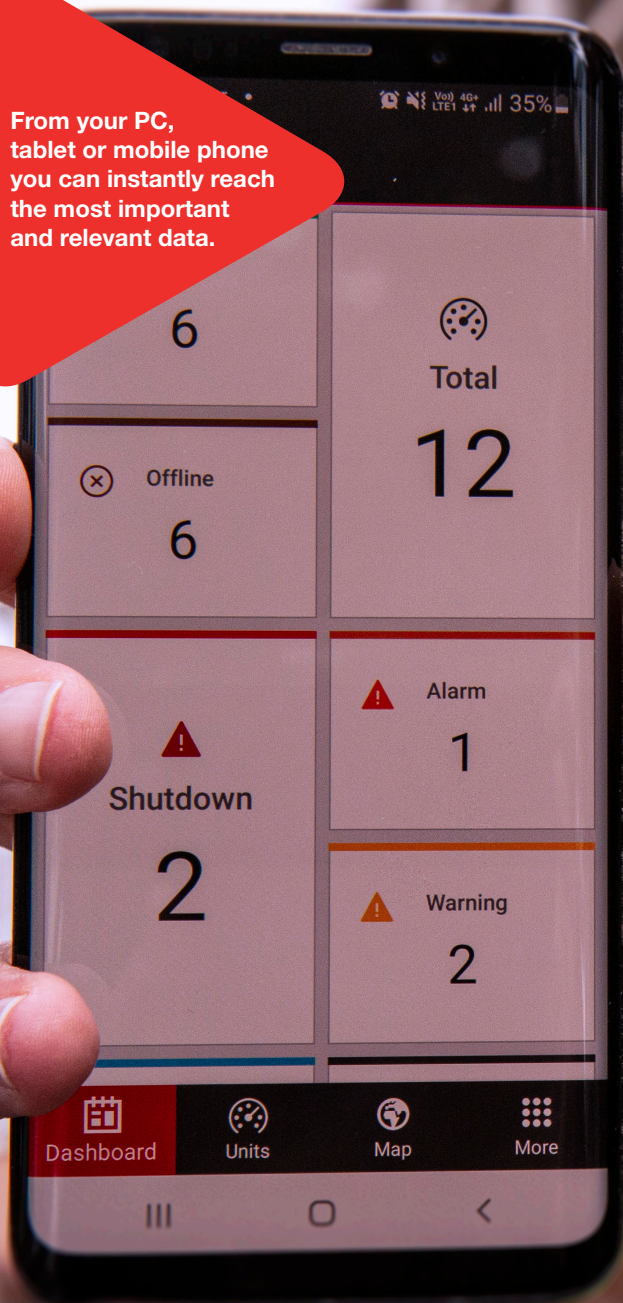

websupervisor.net

Case Studies

We're always proud to showcase the innovative ways that our customers and staff utilize the full potential of our products, keeping ComAp at **the heart of smart control**.

98

case studies via comap-control.com



Don't forget to subscribe to our YouTube Channel to see our latest reference videos.



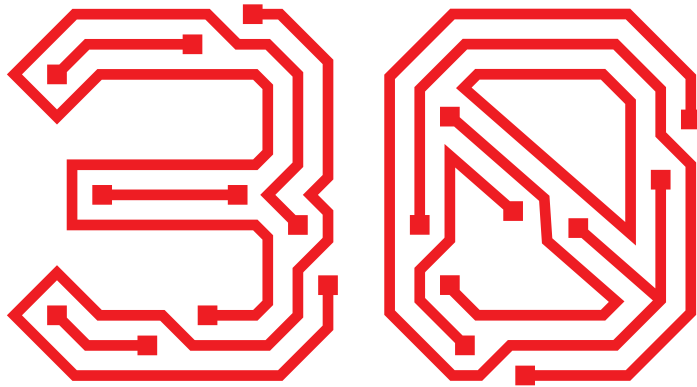

30 Years of Smart Control:

ComAp celebrates 3 decades of success through continuous innovation and growth.

Founded in a one-room office in Prague, Czech Republic in 1991 by three friends, ComAp has since become a successful global company with a strong local presence supported by 13 subsidiaries, more than 400 employees, and a network of 60+ distributors. The company is in the hands of its founders who have an ambitious vision for further growth and investment in acquisitions and partnerships. But it is trusted relationships with customers what is the central focus of ComAp. Let's have a look at the milestones of this astonishing journey starting back in the early 1990s, in the heart of Europe, that has become known as The Heart of Smart Control in the world of independent and backup power generation.



Engine Control

InteliSys | InteliGen

2008
BEST EMPLOYER

Inteli Sys Hybrid

ComAp
Cores

3
We are the heart of

COMAP 1991 - NOW



THE HEART
OF SMART
CONTROL (.EXE)

